

CatchAll™

USER'S GUIDE

3107 Series

- 3 Safety Instructions
- 4 Product View
- 5 Assembly
- 6-9 Operations / Maintenance
- 10 Troubleshooting
- 11 Replacement Parts
- 12 Warranty



Thanks for Buying a CatchAll Bare Floor Cleaner

We're glad you purchased a CatchAll Bare Floor Cleaner. Everything we know about floor care and cleaning went into the design and construction of this handy appliance.

Your CatchAll is well made, and we back it with a limited one-year warranty. We also stand behind it with a knowledgeable, dedicated Consumer Service Department, so, should you ever have a problem, you'll receive fast, considerate assistance.

My great-grandfather invented the floor sweeper in 1876. Today, BISSELL is a global leader in the design, manufacture, and service of high quality homecare products like your CatchAll.

Thanks again, from all of us at BISSELL.

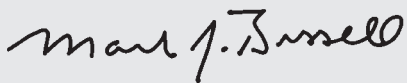

Mark J. Bissell
President and Chief Executive Officer

IMPORTANT SAFETY INSTRUCTIONS

Read all instructions before using your BISSELL CatchAll Bare Floor Cleaner.

When using an electrical appliance, basic precautions should be observed, including the following:

 **WARNING:** To reduce the risk of fire, electric shock or injury:

- Store indoors.
- Do not expose to rain.
- Do not immerse or use on wet surfaces.
- Do not handle with wet hands.
- Do not use the CatchAll if it has been dropped, damaged, left outdoors or dropped into water - have it repaired at an authorized Service Center.
- Do not put any object into appliance openings, or restrict air flow.
- Do not use with any opening blocked.
- Keep openings free of dust, lint, hair, etc.
- Do not use without filter in place.
- Do not pick up hot, burning or smoking objects such as cigarettes, matches or hot ashes.
- Do not pick up flammable or combustible materials (lighter fluid, gasoline, kerosene, etc.) or use in the presence of explosive liquids or vapor.
- Do not use appliance in an enclosed space filled with vapors given off by oil base paint, paint thinner, some moth proofing substances, flammable dust, or other explosive or toxic vapors.
- Do not pick up toxic material (chlorine bleach, ammonia, drain cleaner, gasoline, etc.).
- Do not allow to be used as a toy. Close attention is necessary when used by or near children.
- Be extra careful when cleaning stairs.
- Do not use for any purpose other than described in this User's Guide.
- Use only manufacturer's recommended attachments - use of attachments not provided or sold by BISSELL may cause fire, electric shock or injury.
- Remove battery pack from CatchAll before maintenance or cleaning.
- Use only charging base 310CH supplied by BISSELL to recharge your CatchAll Bare Floor Cleaner.

- Do not use the charging base for any uses other than charging the battery pack 310BP that came with your CatchAll. Other batteries may explode.
- Do not unplug charging base by pulling cord. To unplug, grasp the plug, not the cord.
- Unplug the charging base when not in use and before cleaning or maintenance.
- Use charging base only in standard electrical outlet (120v - 60hz).
- Do not damage the charging cord. Never carry or pull by the cord, use cord as a handle, close door on cord, or pull cord around sharp edges or corners. Keep cord away from heated surfaces. Do not use with damaged cord or plug.
- Do not use an extension cord. DC adapter should plug directly into electrical outlet.
- Do not store or carry battery pack so that metal objects can touch the battery contacts.
- Never attempt to open the battery pack for any reason. If the housing of the battery pack breaks or cracks, immediately discontinue use and do not recharge.
- Do not charge the battery pack if it is wet or shows any evidence of corrosion.
- For best results, do not charge a battery when it or air temperature is BELOW 40° F (5° C) or above 105° F (40° C).

WARNING: The power cord in this product contains lead, a chemical known to the State of California to cause birth defects or other reproductive harm. ***Wash hands after handling.***

This portable hand vacuum contains rechargeable nickel cadmium batteries. Do not incinerate batteries or they will explode when exposed to high temperatures.

Battery cell leaks can occur under extreme conditions. If battery cell liquid comes in contact with the skin:

- Wash immediately with soap and water. Then . . .
- Neutralize with a mild acid such as vinegar or lemon juice.

If battery cell liquid gets into the eyes:

- Flush immediately with clean water for a minimum of 10 minutes.
- Seek medical attention.

SAVE THESE INSTRUCTIONS.

This model is for household use only.

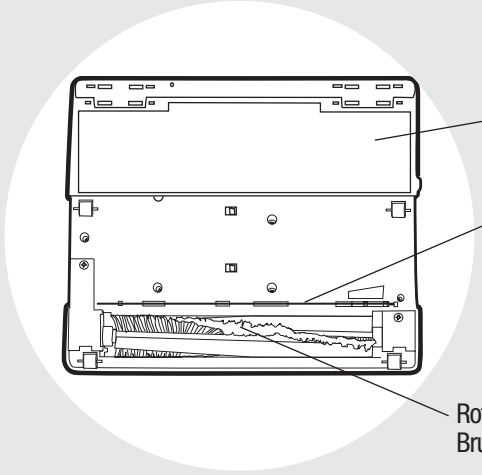

Cloth Holder

Dust Blade

Rotating
Brush/ Blade

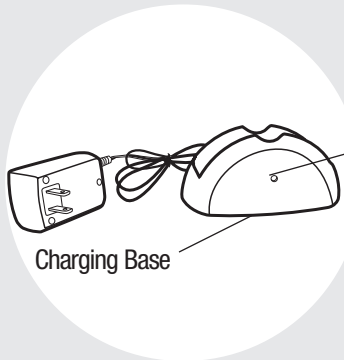

Charging Base

Indicator
Light

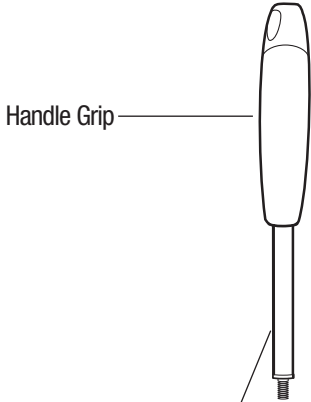

Handle Grip

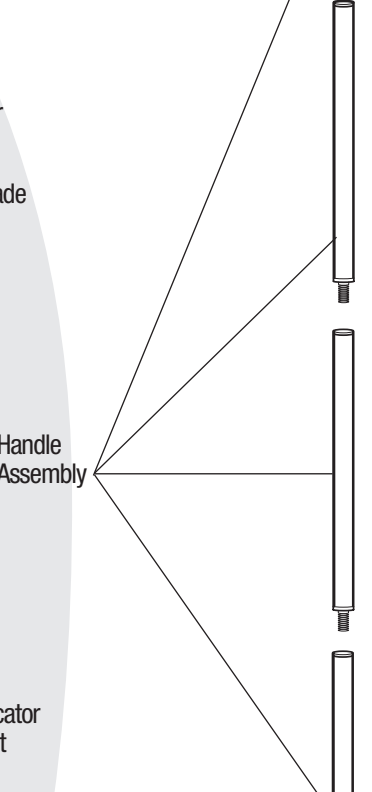

Handle
Assembly

Swivel Handle

Rechargeable
Battery Pack

Cloth Gripper

Dirt Cup and Filter

Dirt Cup
Release

On/Off Button

Rotating
Brush/Blade

Furniture
Protection Guard

How To Use This Guide

This User's Guide has been designed to help you get the most satisfaction from your CatchAll Bare Floor Cleaner. Enclosed you'll find assembly instructions, tips for all cleaning tasks, safety precautions, plus maintenance and troubleshooting instructions.

Please read this Guide thoroughly before using your CatchAll Bare Floor Cleaner. Pay particular attention to the parts diagram, assembly instructions and part names. Following the Guide will greatly enhance your ability to get the most performance from your CatchAll for many years.



WARNING:

Electric/electronic appliances should not be subjected to extreme temperatures or high humidity. Do not store the CatchAll in bathing areas or close to stoves, furnaces or radiators.

How To Put It Together

The CatchAll requires very little assembly. Remove it from the box and check against the illustration to familiarize yourself with the parts. This illustration with part names will also be helpful if you should need to order a part at a later time.

1. Assemble the Handle by screwing together the 4 metal sections, placing the Handle Grip at the top.
2. Screw the Handle Assembly into the Swivel Handle at the top of the cleaner.

Tip:

Fully charge battery before using.

Charging The Battery

1. The Battery Pack is not fully charged when packed in the carton. It should be charged at least 8 hours before using it for the first time. Thereafter, a 6-8 hour charge will renew the Battery Pack.
2. To charge the unit, remove the Battery Pack by gripping it firmly on both sides and lifting up and out. Place the Battery Pack in the Charging Base aligning the metal contacts on the bottom. Plug the DC Adapter of the Charging Base into a standard electrical outlet (120V-60hz). The Indicator Light will glow red, showing the battery is charging.
3. When completely charged, the CatchAll provides over 15 minutes of full cleaning power. An additional Battery Pack may be purchased to extend run time.

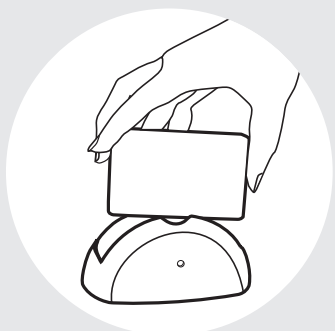
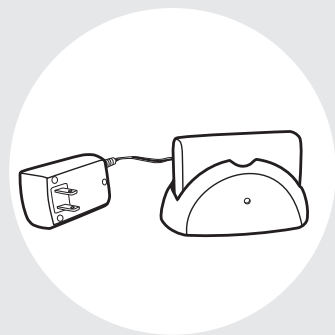

Charging The Battery Continued

4. Decreased operating time may indicate the battery has built up a charging resistance. To recharge, first completely exhaust the battery, recharge it, then exhaust it again before recharging a second time. This procedure may be required more than once.

If your battery still fails to recharge or does not hold a charge of normal duration, call:

BISSELL Consumer Services
1-800-237-7691
Monday – Friday 8 a.m. – 10 p.m. ET
Saturday 9 a.m. – 8 p.m. ET

Or visit our website @ www.bissell.com

Tip:

To extend the life of your batteries remove the Battery Pack from the Charging Base when charging is complete (after 6-8 hours).

How To Use The BISSELL CatchAll

Attaching the Cloth

Note: All popular brands of DRY disposable electrostatic cloths will fit in your CatchAll including Swiffer® and Pledge Grab-it®.

1. Unfold the cloth.
2. Open the Cloth Holder by pushing down on the outside tabs.
3. Place one edge of the cloth into the Grippers on the bottom of the Cloth Holder.
4. Close the Cloth Holder and press firmly to latch into place.
5. Fold the cloth up over the cleaner and push the other edge of the cloth into the Grippers on the top of the cleaner.

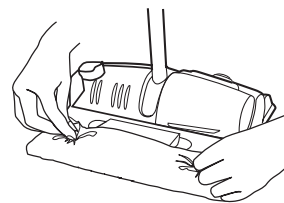
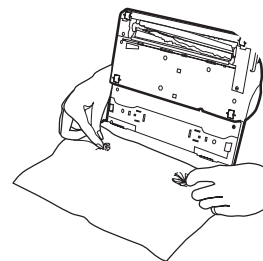
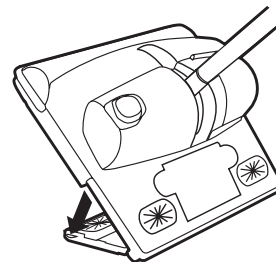

Cleaning Your Bare Floors

- 1.** If the Battery Pack is not already in your CatchAll, remove it from the Charging Base and press firmly into place aligning the metal contacts on the bottom.
- 2.** Tip the Handle back into typical use position. Turn the cleaner on by pressing the On/Off Button on the top of the vacuum.
- 3.** Clean large areas by pushing forward with the Rotating Brush in front. This will allow the vacuum to get the dirt and debris while the cloth dusts your floor.
- 4.** To clean in corners and low-clearance areas, turn the cleaner in the opposite direction to lead with the electrostatic cloth. Any loose dirt or debris can be pushed out and then vacuumed up.
Note: You may also use your CatchAll without the cloth for quick vacuuming pickups. Or you can use the cloth without the vacuum turned on to quickly dust your floors.
- 5.** When you're done, turn the cleaner off by pressing the On/Off button again. The Battery Pack may be left in the cleaner or returned to the Charging Base for recharging.



WARNING:

Use only DRY electrostatic cloths with your BISSELL CatchAll. Use of wet or pre-moistened cloths may damage your cleaner and void the warranty.

Maintenance

The key to maximum performance is emptying the Dirt Cup frequently and cleaning the Filter. Emptying the Dirt Cup after each use, and cleaning the Filter periodically, will help your CatchAll operate at peak efficiency.

Emptying The Dirt Cup & Cleaning The Filter

Use only BISSELL Replacement Filters (203-2518) in your BISSELL CatchAll.

- 1.** With the Rotating Brush facing away from you, push forward on the Dirt Cup Release. Then grasp the Dirt Cup and pull toward you and out.
- 2.** Remove the Filter from the Dirt Cup and empty debris into a garbage container. Shake the Filter to remove any debris.
- 3.** Replace the Filter in the Dirt Cup and place the Dirt Cup back in position in the cleaner.
- 4.** Lock the Dirt Cup into place by pulling the Dirt Cup Release toward the Dirt Cup.
- 5.** After heavy usage, you may clean the Filter by washing it gently by hand in warm water and mild detergent. Rinse thoroughly and make certain it is completely dry before replacing it. If Filter is torn, replace it with a new Filter.

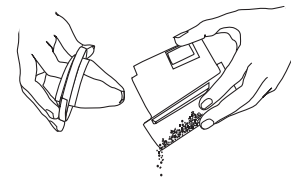
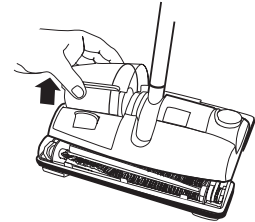
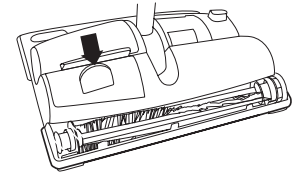

WARNING:

Never operate the CatchAll without the filter in place. Doing so may damage the motor and void the warranty.

Checking the Rotating Brush & Changing the Belt

Use BISSELL Replacement Belts (203-2519) in your BISSELL CatchAll.

- 1.** Remove the Battery Pack from the cleaner.
- 2.** Turn the cleaner over and remove the two screws as shown with a Phillips head screwdriver.
- 3.** Remove both the Brush Covers by pulling up on the end where the screw was and lift out.
- 4.** Remove the Rotating Brush by grasping the Brush or the Blade and pulling up on each end. Note the white End Caps are removable and may come apart from the brush.
- 5.** Clean strings, hair and other debris from the Rotating Brush.
- 6.** If the Belt is broken or worn, remove it and discard. Loop new Belt over the Motor Pulley and notched area of the Rotating Brush. Replace the End Caps and push the Rotating Brush into the slots on the sides as shown. Make sure the Rotating Brush is pushed all the way down and turns freely.
- 7.** Replace the Brush Covers by inserting the notched end under the tab and pushing into place. If you have any difficulty getting the Brush Covers into place, check again to make sure the Rotating Brush is pushed all the way down into the slots. You may need to rotate the End Caps slightly to push into place. Replace the two screws and tighten.

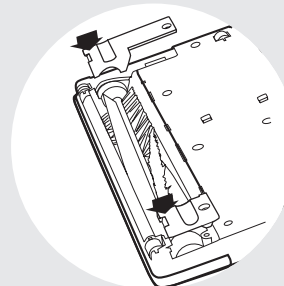
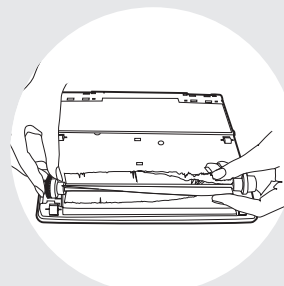
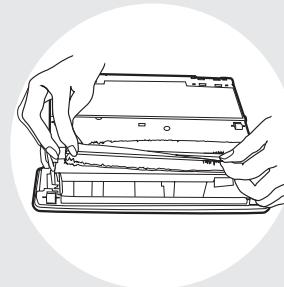
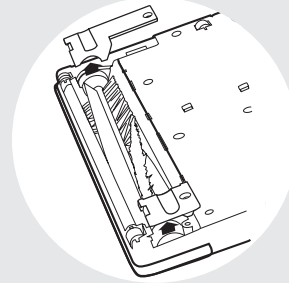
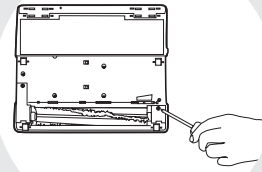

See the following instructions to dispose of the batteries after they have exceeded the battery life.



WARNING: This product contains a nickel-cadmium (Ni-Cd) rechargeable battery pack. According to Federal and State regulations, removal and proper disposal of Ni-Cd batteries is required. For disposal of the Battery Pack in your CatchAll, see instructions below:



1. Keep Battery Pack together - DO NOT separate individual batteries.
For specific disposal instructions of batteries, please contact:
RBRC (Rechargeable Battery Recycling Corporation) 1-800-822-8837 or
visit the website: www.rbrc.com
2. Replace the Battery Pack using only BISSELL parts or discard the remainder of the product.

Troubleshooting

Not Powered/Underpowered

Possible Causes

- 1 Battery Pack not charged thoroughly
- 2 Battery Pack not firmly inserted

Remedies

- 1 Make sure Battery Pack has been placed in Charging Base for the recommended amount of time; Check to be sure the Battery Pack is fully inserted in the Charging Base; Check to make sure the Indicator Light is glowing, if not, check electrical plug
- 2 Press the Battery Pack firmly into the cleaner; Make sure the metal contacts are aligned

Vacuum Cleaner Won't Pick Up Dirt Or Not Vacuuming Effectively

Possible Causes

- 1 Dirt Cup is full
- 2 Filter is dirty
- 3 Dirt Cup is not locked in place
- 4 Rotating Brush is not turning

Remedies

- 1 Empty Dirt Cup
- 2 Clean Filter
- 3 Make sure the Dirt Cup is fully inserted and locked in place
- 4 Check the Rotating Brush and clean; Check Belt and replace if needed

If suggested solutions for this or any function of the CatchAll do not correct the problem, call BISSELL Consumer Services.

Replacement Parts

You may purchase replacement parts from your retailer, by calling BISSELL Consumer Services or by visiting our website. To locate a retailer near you, or to place an order using VISA, MasterCard, Discover, or American Express, call:

BISSELL Consumer Services

1-800-237-7691

Monday - Friday 8 a.m. — 10 p.m. ET

Saturday 9 a.m. — 8 p.m. ET

or visit the BISSELL website - www.bissell.com

Item	Part Number.	Part Name
1	203-2518	Filter Pack (2 pack)
2	203-2519	Belt (2 pack)
3	203-2520	Rechargeable Battery Pack
4	203-2521	Charging Base
5	203-2522	Handle Assembly (4 sections)
6	203-2523	Dirt Cup
7	203-2524	Rotating Brush/Blade
8	310EC	Electrostatic Cloths (20 pack)
9	203-6500	Electrostatic Cloths (12 pack)

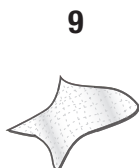
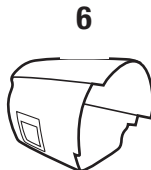
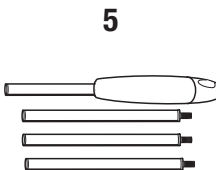
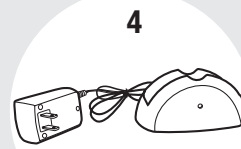
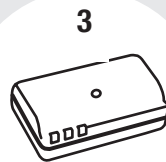
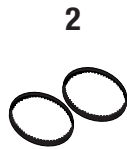
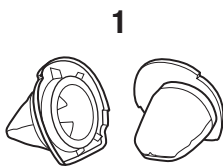

Warranty

This warranty gives you specific legal rights, and you may also have other rights which may vary from state to state. If you need additional instruction regarding this warranty or have questions regarding what it may cover, please contact BISSELL Consumer Services by e-mail, telephone, or regular mail as described below.

Limited One Year Warranty

Subject to the *EXCEPTIONS AND EXCLUSIONS identified below, upon receipt of the product, BISSELL Homecare, Inc. will repair or replace (with new or remanufactured components or products), at BISSELL's option, free of charge from the date of purchase by the original purchaser, for one year any defective or malfunctioning part.

See information below on "If your BISSELL product should require service."

This warranty applies to product used for personal, and not commercial or rental service. This warranty does not apply to fans or routine maintenance components such as filters, belts, or brushes. Damage or malfunction caused by negligence, abuse, or use not in accordance with the User's Guide is not covered.

If your BISSELL product should require service:

Call BISSELL Consumer Services at the number listed below or visit the BISSELL website - www.bissell.com to locate a BISSELL Authorized Service Center in your area.

If you need information about repairs or replacement parts, or if you have questions about your warranty, contact BISSELL Consumer Services.

Website or E-mail:

www.bissell.com
Use the "Customer Services" tab.

Or Call:

BISSELL Consumer Services
1-800-237-7691
Monday - Friday 8 a.m. - 10 p.m. ET
Saturday 9 a.m. - 8 p.m. ET

Or Write:

BISSELL Homecare, Inc.
PO Box 3606
Grand Rapids MI 49501
ATTN: Consumer Services

BISSELL HOMECARE INC. IS NOT LIABLE FOR INCIDENTAL OR CONSEQUENTIAL DAMAGES OF ANY NATURE ASSOCIATED WITH THE USE OF THIS PRODUCT. BISSELL'S LIABILITY WILL NOT EXCEED THE PURCHASE PRICE OF THE PRODUCT.

Some states do not allow the exclusion or limitation of incidental or consequential damages, so the above limitation or exclusion may not apply to you.

*EXCEPTIONS AND EXCLUSIONS FROM THE TERMS OF THE LIMITED WARRANTY

THIS WARRANTY IS EXCLUSIVE AND IN LIEU OF ANY OTHER WARRANTIES EITHER ORAL OR WRITTEN. ANY IMPLIED WARRANTIES WHICH MAY ARISE BY OPERATION OF LAW, INCLUDING THE IMPLIED WARRANTIES OF MERCHANTABILITY AND FITNESS FOR A PARTICULAR PURPOSE, ARE LIMITED TO THE ONE YEAR DURATION FROM THE DATE OF PURCHASE AS DESCRIBED ABOVE.

Some states do not allow limitations on how long an implied warranty lasts, so the above limitation may not apply to you.

Swiffer® is a registered trademark of the Procter & Gamble Company.

Pledge Grab-it® is a registered trademark of S.C. Johnson & Son, Inc.



©2003 BISSELL Homecare, Inc.
Grand Rapids, Michigan
All rights reserved. Printed in China
Part Number 603-2539
Rev 07/03
Visit our website at:
www.bissell.com